

Features

- Four adjustable tempered-glass shelves.
- Full-overlay mirrored door.
- Mirrors on back of door and interior back of cabinet.
- Can be installed with left- or right-hand swing.
- Includes mounting hardware for surface or recessed installation.
- Multiple cabinets can be joined horizontally with ganging kit (sold separately).
- Requires K-2878 side mirror kit (sold separately) for surface mount installation.

Material

- Anodized aluminum construction with a durable rust-proof and chip-resistant finish.
- Anodized aluminum construction with a durable rust-proof and chip-resistant finish.

Required Products/Accessories

K-2878 Mirrored side kit for Catalan® medicine cabinets

Recommended Products/Accessories

K-23723 Faucet cleaner

Optional Products/Accessories

K-2879 Ganging Hardware



Codes/Standards

None Applicable

KOHLER® One-Year Limited Warranty

See website for detailed warranty information.

Available Colors/Finishes

Color tiles intended for reference only.

Color	Code	Description
-------	------	-------------

	SAA	Satin Anodized Aluminum
---	-----	-------------------------

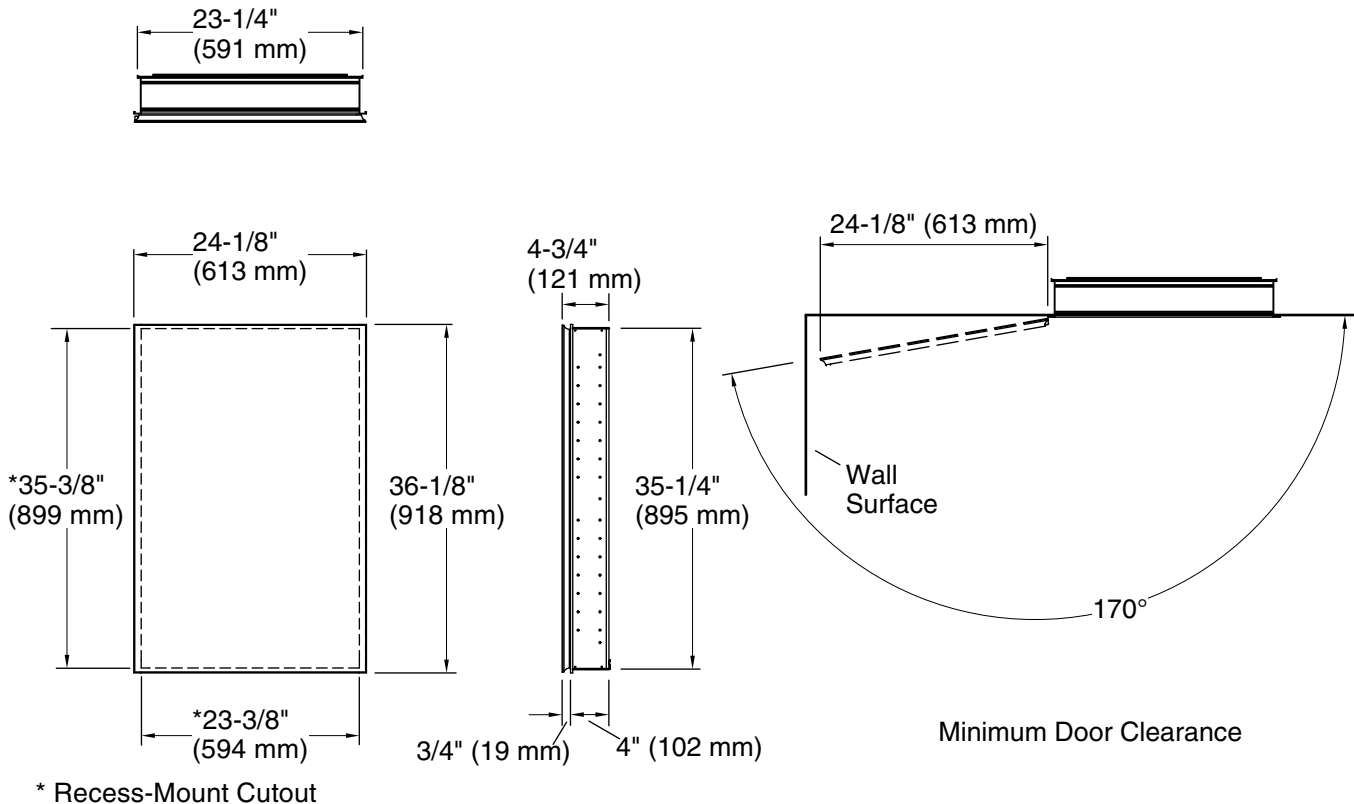

Technical Information

All product dimensions are nominal.

Notes

Install this product according to the installation guide.

When determining the height of the medicine cabinet, ensure the mirrored door will clear all obstacles (such as a faucet). A minimum distance of 3" (76 mm) is required.

To find the combined roughing-in width for joined cabinets, add the roughing-in width for each cabinet and add 1" (25 mm) for each ganging kit.

Secure the screws (provided) to a stud to avoid possible property and product damage. If this is not possible, anchors (not provided) must be inserted before installing the screws.

Roughing-in opening for recess-mount installations: 23-3/8" (594 mm) x 35-3/8" (899 mm) x 4" (102 mm).